

The logo for MecVel, featuring a stylized eye icon to the left of the brand name "MecVel" in a bold, italicized sans-serif font, with a registered trademark symbol (®) to the upper right of the "l".

**MecVel<sup>®</sup>**





The CE mark, consisting of the letters "C" and "E" in a stylized, bold font, indicating compliance with European standards.

**CE**

**Attuatore Elettromeccanico  
Electromechanical Actuator**

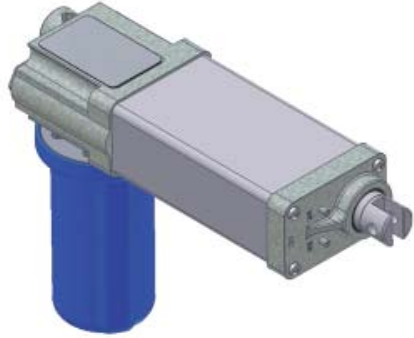
**ALI1  
ALI1-P**

**Manuale di Uso e Manutenzione  
Use and maintenance handbook**

ALI1	ALI1-F
	
ALI1-P	ALI1-PF
	
ALI1-R	ALI1-PR
	

<b>1 GENERAL RULES AND REMARKS .....</b>	<b>26</b>
1.1 Introduction .....	26
1.2 Law references .....	26
1.3 CE marking .....	26
<b>2 DESCRIPTION OF THE MACHINE AND TECHNICAL FEATURES .....</b>	<b>27</b>
2.1 Configurations of ALI1 models .....	27
2.2 Description of the components and options .....	28
2.2.1 Motorizations .....	29
2.2.2 Gear boxes .....	29
2.2.3 Lead screws .....	29
2.2.4 Actuator stroke control .....	29
2.2.5 Ends and fastening devices .....	29
2.2.6 Antirotation device .....	30
2.2.7 Lubricants .....	30
<b>3 TRANSPORT AND DISPOSAL .....</b>	<b>30</b>
3.1 Disposal .....	31
<b>4 INSTALLATION .....</b>	<b>32</b>
4.1 Installation instructions .....	32
4.2 Stroke control system setting .....	34
4.3 Connections .....	35
4.3.1 Electric connection .....	35
4.4 Duties of the end user .....	35
<b>5 WORKING AND USE .....</b>	<b>36</b>
5.1 Working .....	36
5.2 Use and usage conditions .....	36
5.3 Preparation of working and duty cycles .....	38
5.4 Residual risks .....	39
<b>6 ACTUATOR MAINTENANCE .....</b>	<b>39</b>
6.1 General cautions and hints .....	40
6.2 Actuator service operations .....	40
6.3 Actuator repair .....	41
6.4 Actuator replacement .....	41
<b>7 MANUAL DRIVE .....</b>	<b>42</b>
<b>8 INTERACTION WITH THE OPERATOR .....</b>	<b>43</b>
<b>9 GENERAL WARRANTY CONDITIONS .....</b>	<b>43</b>
<b>10 REMARKS .....</b>	<b>43</b>

---

---

## 1 GENERAL RULES AND REMARKS

### 1.1 INTRODUCTION

This handbook is property of MecVel s.r.l. All rights are reserved, hence it is forbidden to copy and transfer to others this document contents.

MecVel s.r.l. has the right to modify this handbook, without any need for preliminary information.

Before using this product( o actuator), we strongly recommend to read this document carefully.

**The actuator is not and must not be considered as a safety device.** The final user, or the manufacturer of the machine or system, in which the actuator is installed, has the responsibility for the safety of the machine or system itself and he must install the actuator only in accordance to the current rules for safety of the land where the machine is used.

This handbook is about the range of ALI1 actuators, described in the next chapters.

### 1.2 LAW REFERENCES

The safety rules applied by the manufacturer for the design and the production of this apparatus, in accordance with “CE” marking are described in the technical brochure, section nr. 3, property of MecVel s.r.l.

REMARK: For further explanations and details, please contact MecVel s.r.l.

### 1.3 CE MARKING

Each actuator is provided with a label, containing the following details:

- **manufacturer's name**
- **model**
- **year of production**

As an example, here below you can find one of the labels applied by MecVel s.r.l.



## 2 DESCRIPTION OF THE MACHINE AND TECHNICAL FEATURES

COMPONENT/OPTION	FEATURES/VALUE
DC Motor	12 / 24 / 36 Volt
Gearing	Worm screw - Worm wheel
Mechanism	Cold-rolled profile ACME + Nut
Push rod	Aluminium (stainless steel upon request)
Ends, joints, fastening devices	Rear Front
Stroke control devices	Encoder Mechanical, by microswitch
Lubrication	Permanent with grease
Protection level	Depending on customer's demand (MAX IP65)
Weight	Depending on the configuration (For ex: 1 Kg for 100 mm stroke)

Possible actuator configurations are listed below, with the following codes:

**MOD. ALI1**                                      **MOD. ALI1-P**  
**MOD. ALI1-F**                                   **MOD. ALI1-PF**  
**MOD. ALI1-R**                                   **MOD. ALI1-PR**

REMARK: *Customized configurations can be carried out . To check if these configurations comply with this handbook, please contact the manufacturer.*

### 2.1 CONFIGURATIONS OF ALI1 MODELS

For the technical features description of the following configurations components and devices, please see section 2 *TECHNICAL FEATURES* of this handbook.

MODEL	MOTOR*	GEARS	LEAD SCREW	PUSH ROD	END SWITCHES
ALI1	A or B	VR	TR	AL. (standard) / STAINLESS STEEL (on request)	-
ALI1-F	A or B	VR	TR	AL. (standard) / STAINLESS STEEL (on request)	F
ALI1-R	A or B	VR	-	-	-
ALI1-P	B	2 VR	TR	AL. (standard) / STAINLESS STEEL (on request)	-
ALI1-PF	B	2 VR	TR	AL. (standard) / STAINLESS STEEL (on request)	F
ALI1-PR	B	2 VR	-	-	-

mod. ALI1

\* see below table.

LEGEND:

- NOT AVAILABLE
- VR WORM SCREW - WORM WHEEL
- 2 VR DOUBLE REDUCTION WORM GEAR-BOX
- TR COLD - ROLLED ACME PROFILE
- F MECHANICAL STROKE LIMIT DEVICE WITH MICROSWITCH

MOTOR TYPE	A	B
MOTOR SIZE	40S (24V)	40L (12, 24, 36 V)

## 2.2 DESCRIPTION OF THE COMPONENTS AND OPTIONS

Concerning technical features and performances, please refer to the catalogue of the product. From the below drawing, you can identify the main components of the different models of this actuator.

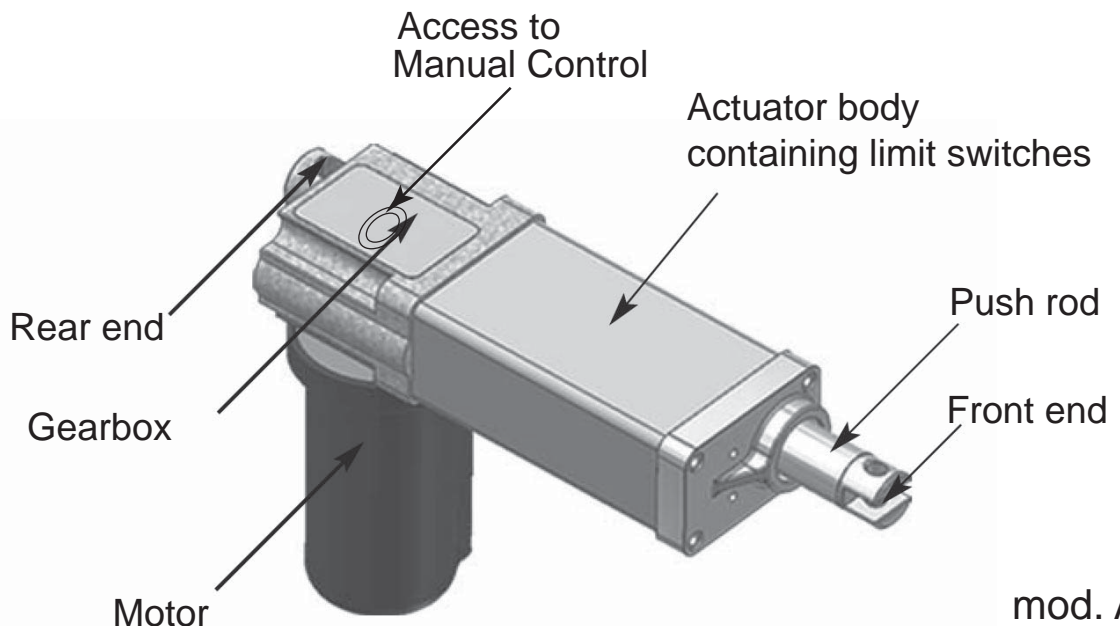
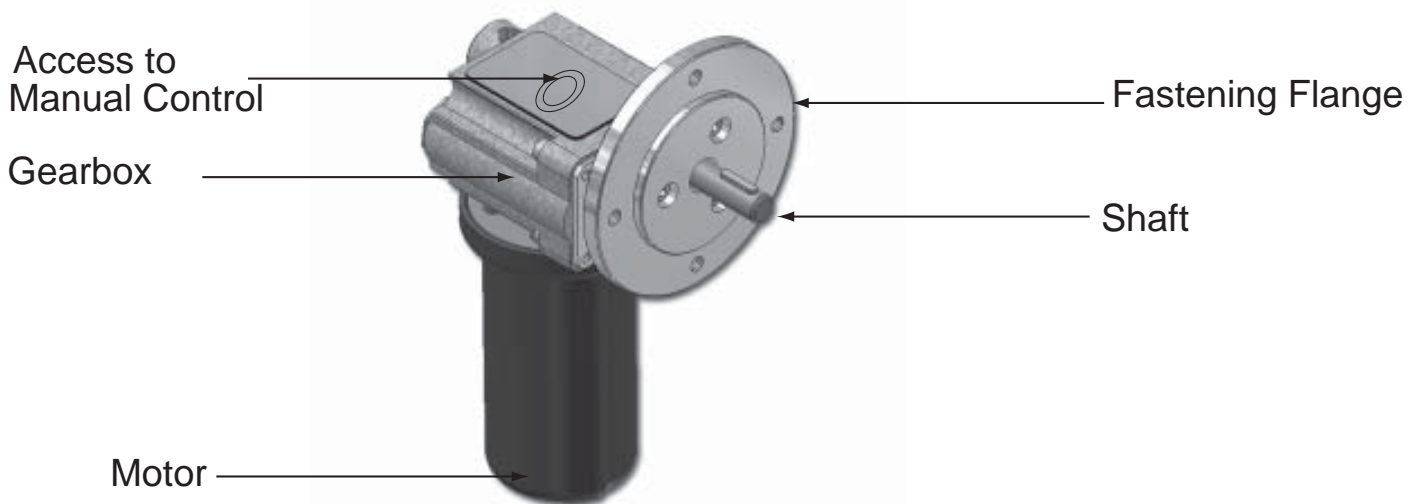

### **2.2.1 Motorizations**

Available only with permanent magnets DC motors.

Possible voltages are 12, 24 and 36 V.

To choose the right motorization, we suggest to read the catalogue.

### **2.2.2 Gearbox**

Steel wormscrew and wormwheel made of special plastic or bronze materials, to meet different needs in terms of performances low noise, lifetime, backlash, etc.

### **2.2.3 Lead screws**

Basically made of C-20 steel and featuring cold-rolled profile; it is coupled with bronze or polymer nuts in order to grant safety against loads and low noise.

### **2.2.4 Actuator stroke control**

Different types of stroke control devices can be applied to actuators: from simple microswitches, mechanical or magnetic, providing a signal to control motor supply (ON/OFF), up to electronic devices to obtain servo-mechanisms.

The types of devices available on ALI1 are:

#### **Mechanical stroke control with microswitches**

There are 2 or more changeover single - contact cam operated microswitches, integrated into the actuator protective tube. They are switched by a rod tied to the push rod. This device is adjustable.

#### **Encoder**

It is an incremental rotative transducer, that turns spinning movements into digital pulses. It can be installed on actuators by using a longer wormscrew coming out the gear-box on the opposite side of the motor, or directly on board on the back of the motor itself. Its digital output allows for a feedback on actuator position, yet, every time there is a machiner reset, encoder shall be given the zero position.

### **2.2.5 Ends and fastening devices**

Both standard and dedicated ends (according to customer's drawing) are available.

Ends shall be carefully chosen, in order to avoid radial loads on actuator. Please note that front end receives reaction spinning torque when load is acting on actuator, so when yoke or balljoint ends are used, antirotation key is advisable.

It is important to keep the front and back fixing. Ends with parallel axis when mounting

mod. ALI1

the actuator, in order to avoid having an iperstatic system, which would damage the actuator.

### 2.2.6 Antirotation device

Antirotation device is needed when the application does not allow preventing from rotating: in other words if the load is not guided. This device is realized by a long key fixed inside of the outer tube and a keyway cut into the nut, or by a safety nut with special slide running along a slide installed into the outer tube.

### 2.2.7 Lubricants

The technical features of the standard lubricants are shown on the below tables. For specific uses special lubricants are available: in this case, please contact the MecVel Technical Dept.

#### STANDARD LUBRICANTS

Brand	Product	Min. T	Max. T	Drop T	Base oil	Thickener	NLGI Class
Vanguard	G.S. Friction 2	-45 °C	+150 °C	+180 °C	Synthetic	Lithium hydroxide	2

#### EQUIVALENT LUBRICANTS

Brand	Product	Min. T	Max. T	Drop T	Base oil	Thickener	NLGI Class
Clueber	Isoflex LDS 18 Special A	-50 °C	+120 °C	-	Synthetic	Lithium complex	2
Dow Corning	Molykote BG20	-45 °C	+180 °C	+290 °C	Synthetic ester	Lithium complex	2

For deeper technical features and performances, please see the manufacturer's catalogue.

## 3 TRANSPORT AND DISPOSAL

The product is supplied in carton or wooden boxes with or without pallets, depending on the agreements taken with the customer and on the dimensions/weight of the product itself. After unpacking, we recommend to move the products using adequate systems (such as fork lifts, transpallets, safety belts).



It is important that the operator pay attention to the safety conditions for the product transport. In particular, please remember to wear appropriate safety clothes, such as safety shoes and gloves, to avoid damages or injuries caused by an accidental fall of the product.

The weight of an actuator is reported in the table of section 2. Up to a weight of 10 Kg the actuator can be moved without using any particular tools, but please consider that for actuators with strokes longer than 500 mm, the barycenter shifted towards the motor can cause difficulties during the transport and it can be necessary the help of a second operator or of suitable tools. We strongly recommend to move the actuator box with the maximum care, to avoid that accidental collisions damage the actuator.

### **3.1 DISPOSAL**

Hereafter is the list of the products connected with the actuator, that have to be disposed, in accordance with the current rules with the Country in which the product is installed and used:

- Package, during the installation;
- Actuator components, if replaced or repaired;
- Lubricants, after the cleaning or service of the actuator;
- Actuator itself, if replaced or repaired.

Please dispose of all waste carefully.

---

## 4 INSTALLATION

### 4.1 INSTALLATION INSTRUCTIONS

The actuator shall be installed paying attention to have only axial forces applied to it. It is important to get the mounting points perfectly alligned. They have to be chosen, taking into consideration the loads with which the actuator has to work, in order to avoid misalignements that would cause grease loss and non-regular working.

To guarantee stability of the actuator, a safe and stable installation, according to the following instructions, is recommended:

1. Front and rear connection points must have parallel axis;
2. Fix the rear connection point so that the actuator is strongly fastened to the structure;
3. connect the load to the front end of the actuator, using suitable fastening devices (tie - rods, screws, pins, etc.);
4. proceed with the electric connection.



**OFF - SET LOADS, DUE TO WRONG SELECTION OF ACTUATOR'S FIXING-ENDS OR INSTALLATION MISTAKES, WITH NON ALIGNED ENDS, LEAD TO SIDEFORCES ON ACTUATOR PUSH ROD CAUSING UNEXPECTED WEAR, LUBRICANT LOSS AND NON REGULAR WORKING.**

Actuator shall work within its nominal stroke, avoiding mechanical end stops.

Running against mechanical stops cause serious damage of internal actuator parts.

Before starting the actuator, following check-ups shall be performed:

- If actuator is equipped with electric limit switches, before starting the motor, be sure they have been connected and ensure they work properly, in order to avoid any mechanical end - stop.
- Make sure that push rod is regularly travelling and limit switches are correctly adjusted. Drive the actuator "step-by-step" to check all this.
- The first time you switch on the actuator it is advisable to start from the middle of the stroke to avoid damages due to starting the motor in the wrong direction and hitting the stroke end.
- Make sure that there are no interferences between the push rod and other parts of the machine or system on which the actuator is installed.

*REMARK: check catalogue for more explanations about actuator stroke (contact MecVel s.r.l.).*



**IN CASE LIMIT SWITCHES ARE ALREADY ADJUSTED BY THE MANUFACTURER, MANUAL ROTATION OF THE PUSH - ROD WILL CAUSE ADJUSTMENT LOSS!**

When installing the actuator, to avoid accidental overloads, we suggest to install a current overload relay on general control panel. Its function is to cut off the power supply when actuator current consumption is overriding a chosen limit. In fact, being current proportional to load, this device avoids actuator to be accidentally overloaded.

*REMARK: Current threshold shall be adjusted not to react towards current spikes on motor startups.*



**PLEASE NEVER SWITCH ON THE ACTUATOR, BEFORE HAVING CORRECTLY COMPLETED ALL THE POSITIONING OPERATIONS.**

## 4.2 STROKE CONTROL SYSTEM SETTING

### SETTING LIMIT SWITCHES

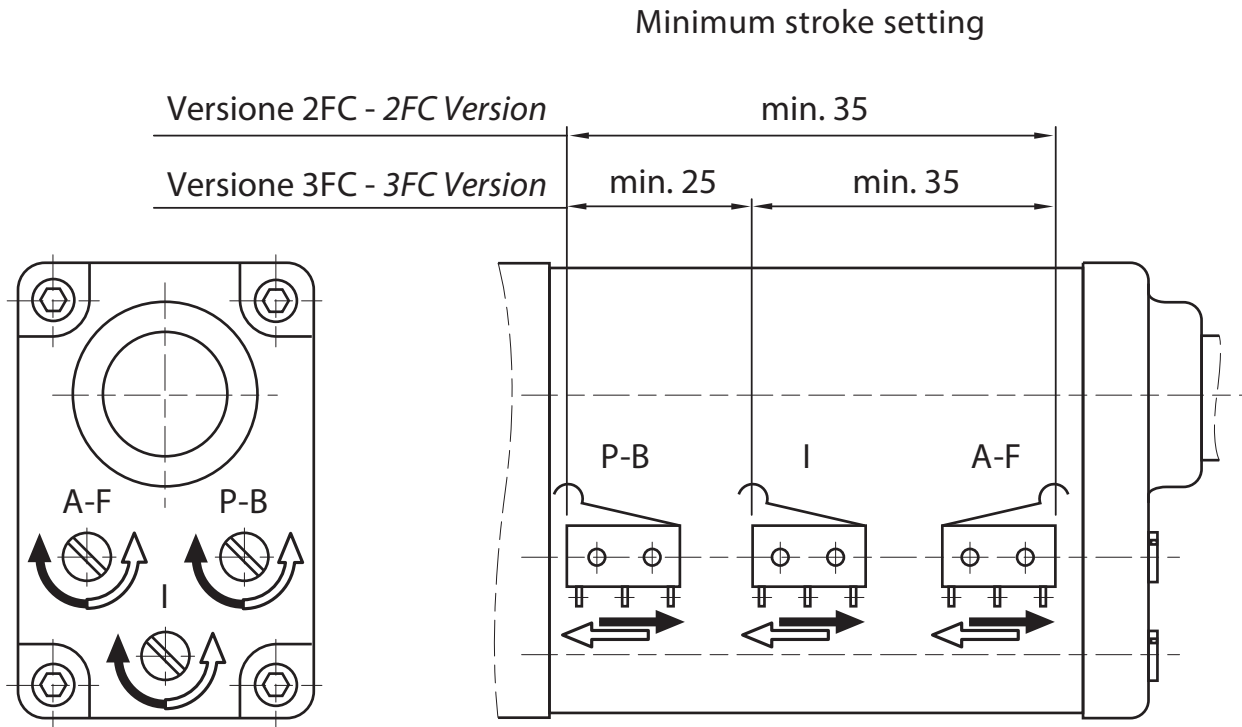

### LIMIT SWITCHES

This model is equipped with two limit switches (featuring one contact each). A version with a third limit switch, central positioning, is available.

Intermediate position changes according to push-rod moving direction. Tuning is adjusted by turning screws on actuator header. Each clock wise turn of the screw allows the micro switch to go 0.7 mm. forth, towards the header itself.

Look at the drawing to see how it works; letters have following meaning:

A-F= Front

I= Intermediate

P-B= Back

### ENCODER

Encoder opposite side of motor available only on ALI4 and ALI4-F

- Encoder Power Supply 3,8 V - 24 Vdc
- PUSH-PULL
- 2 CH - 4 ppr
- Maximum output current: 100 mA

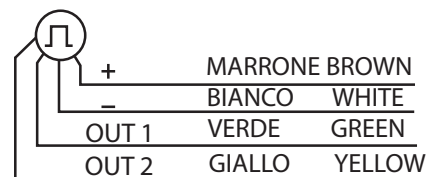

## 4.3 CONNECTIONS

### 4.3.1 Electric connection



**THESE OPERATIONS MUST BE DONE BY QUALIFIED AND AUTHORIZED PERSONNEL.**

Once installation is completed, following the above described instructions, the stroke control devices (if present) can be activated, by connection of the supply cable to the general control panel.

Connection operations must be done with the maximum attention to safety, using the proper safety tools (such as gloves, glasses, etc.).

Reference drawings for the electric connection are available on the catalogue of the product (contact MecVel s.r.l.)

*REMARK: If a brakemotor is driven by a frequency converter, brake shall get a separate power supply.*

## 4.4 DUTIES OF THE END USER

The end user must install the machine in suitable places, equipped with electrical system and lighting, according to the rules in force.

We recommend, moreover, the installation of the electricity in dry and lighted places, with temperature, humidity, etc., comply with the limits indicated by the laws in force.

In particular, the end user shall install on board of the machine the following devices:

- Device for the automatic interruption of the current (magnetothermic switch), controlling the functions of direct and indirect electrical connections, as well as protecting the electrical devices from overloads;
- A locked disconnecter, for maintenance operations, of the suitable size, that gathers all the current supply of the actuator, before it reaches all the different tools;
- Earthing to control indirect contacts and air discharges.

Remember to use disconnecters of the right dimension for the number and type of actuators that they have to disconnect. Please refer to the electric features described on the use and maintenance handbooks.

All these devices shall be installed in a general control panel, adequate to the application.

In case of additional end stroke devices, it is up to the installer to supply them by a current transformer.

The manufacturer cannot be considered as liable in case of loss of performance and/or damages to people or animals, if the installation instructions are not fulfilled as here recommended.

Please contact the manufacturer to verify the compatibility of the work place with the actuator itself.

*REMARK: By laws/rules in force, it is meant the legislation of the Country in which the actuator is used.*

## 5 WORKING AND USE

### 5.1 WORKING

This machine is used for loads movement. It is made up by an electrical motor, driving a lead screw directly or with a gearbox. A nut is then allowed to move along lead screw, and its movement drives push rod connected the nut itself.

Load shall be axial only, but it can be tensile or pushing, no matter what push rod direction is. The actuator can be selflocking or non-selflocking. Anyway, there is not a sharp threshold between selflocking and non-selflocking, because this feature is affected by gears wear, load, vibrations. In case of doubt about actuator behaviour, it is necessary to do some tests and to contact the manufacturer.

*REMARK: We would like to stress that the selflocking of the actuator limits its accuracy and the repeat of the positioning. In case of doubts, please contact MecVel s.r.l.*

### 5.2 USE AND USAGE CONDITIONS

The actuator is designed for the use conditions specified by the manufacturer and explained on the catalogue of the product.

The supply is in AC or DC, but it is also possibile to drive it manually, in case of emergency, through second shafts or stretched wormscrews acting as second shafts. Before starting with manual operation, it is important to disconnect the power supply of the actuator.

About use, it is important to define the actuator duty cycle and the environment.

These parameters need to be analyzed as linked together. Duty cycle is percentage rate between on-time and idle-time, on a timeframe of 5 mins.

Environment is mainly due to temperature and related elements, which can sometimes create an aggressive environment (humidity, dust...). A bellow protecting push rod is available: pharmaceutical and food industry or aggressive environment are typical examples of applications where this item can be requested; in any case, under such circumstances, please contact the manufacturer.

**Standard duty cycle for our actuators is rated in S3-30% and the temperature gap is -10°C/+60°C, the pressure range is 0,8-1,1 bar.**

Duty cycle can vary depending on the configuration and on the usage of the actuator. In any case, it is indicated on the label on the product. In case of doubt, please contact the Technical Dept. of MecVel s.r.l.

The below table shows how to determine the actuator actual stroke. It depends on the speed and the weight of the lead screw (in case of assembling on the horizontal axis. Actuator shall work within stroke settled. During the project of the application, some 10 mm extra stroke (in both directions) are to be considered: lower possibilities of mechanical end - stops will then be involved.

*REMARK: Running on block cause serious damage of actuator! For strokes 20 times larger than lead screw diameter, it is important to consider 150 mm of extra stroke, instead of 10 mm to avoid off set loads and compensate buckling effect.*

*REMARK: Off set load lead to side-forces on actuator axis, unexpected wear, lubricant loss and non regular workout.*

The diagram shows how to see what is max load admitted by a lead screw, basing upon its lenght and upon how actuator will be fixed on frame. As a general rule, choice is:

Actuator series	Diagram
Actuator with stroke 15 - 20 time lower than lead screw diameter	C
Actuator with stroke 15 - 20 time larger than lead screw diameter	B



**THE STANDARD MODEL OF ACTUATOR CANNOT BE USED IN EXPLOSIVE OR POTENTIALLY EXPLOSIVE ENVIRONMENT.  
FOR FURTHER INFORMATION REGARDING THE USE OF THE PRODUCT IN THESE CONDITIONS, PLEASE CONTACT MECVEL S.R.L.**

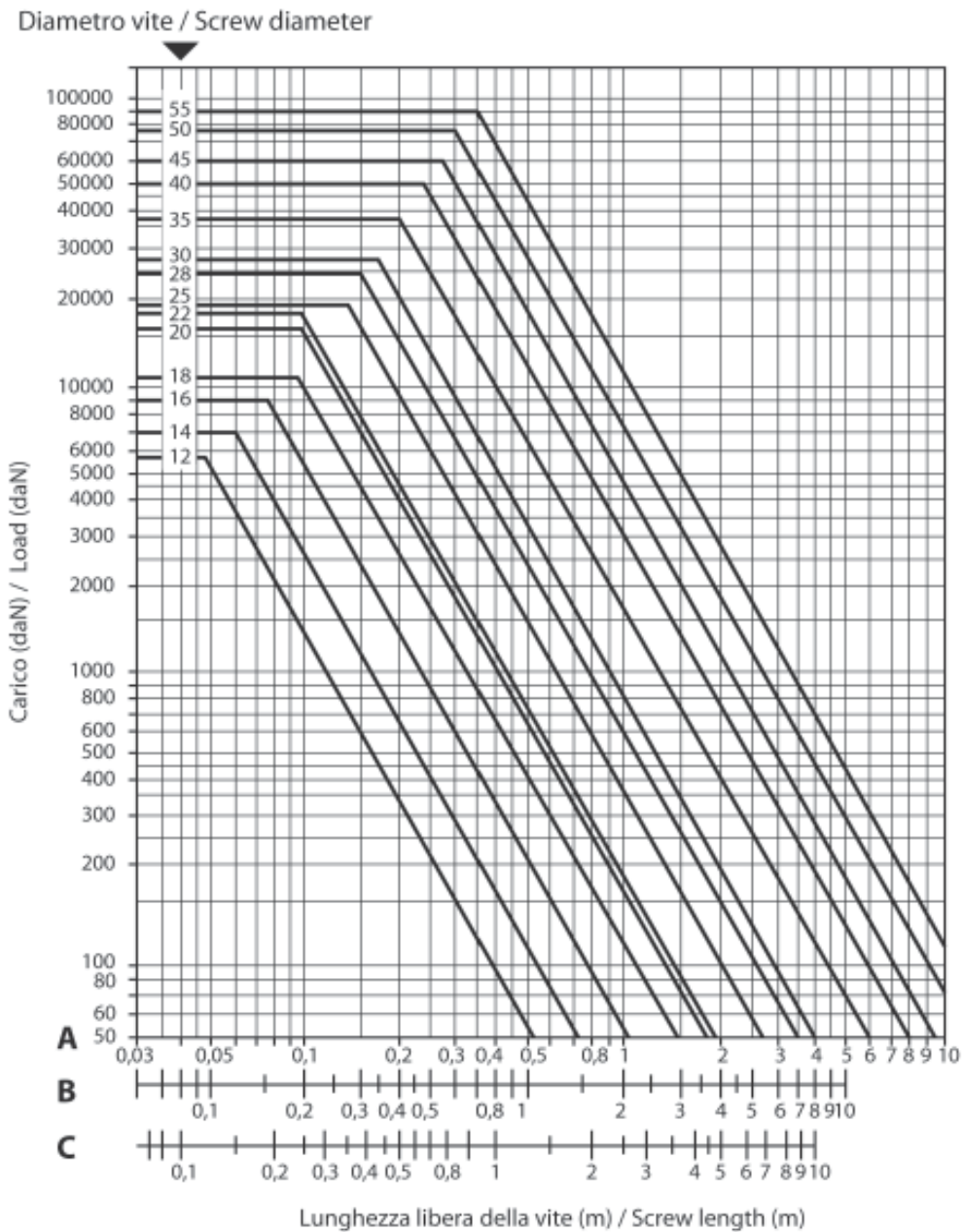

### 5.3 PREPARATION OF WORKING AND DUTY CYCLES

Before starting the duty cycle, following checks have to be carried out:



- correct installation of the actuator;
- correct setting of the stroke control devices, if present;
- correct application of the load, with reference to the guidelines of this handbook.

It is necessary to consider the linear speed along stroke together with the load dynamics, in order to avoid inertias or vibrations. In case this situation might happen, we suggest to contact the Technical Department of MecVel s.r.l. to check the correct choice of the actuator, comparing with its dimensions.

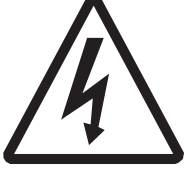

## 5.4 RESIDUAL RISKS

The risks analysis and evaluation has shown that, even though all the possible measures to avoid dangers from the actuator use have been adopted, still some residual risks exist. In this section, we will explain all the cares that the operator shall adopt to avoid this residual risks. We will also show the signs used to indicated these risks on the machine.

RESIDUAL RISK	COMPONENT	PROCEDURE	SIGN
Parts in tension	Motor and electric parts	Before proceeding with any operation on the actuator, the operator must switch power off.	
Hot parts	Motor, electric parts, push rod, reduction unit	Wear the necessary clothes. Before proceeding with any operation, the operator must wait until all the hot parts are cooled.	
External parts in movement	Push rod	Before proceeding with any operation, switch power off. Do not wear clothes that can be dragged in the machine.	

## 6 ACTUATOR MAINTENANCE



**DURING MAINTENANCE OPERATIONS, PLEASE TAKE ALL THE NECESSARY CARES, TO AVOID ANY DANGER FOR THE OPERATOR. WE RECOMMEND TO CAREFULLY READ THIS CHAPTER OF THE HANDBOOK FOR USE AND MAINTENANCE.**

## 6.1 GENERAL CAUTIONS AND HINTS

All the maintenance operations must be done by qualified and authorized technicians, adequately informed and trained about the dangers, arising from them.

Moreover, it is important to consider the integration and usage of the actuator into more complicated systems.

If the actuator is installed in dangerous environment, the operators must behave accordingly, for example, wearing protecting masks, glasses, etc.

All the operations must be fulfilled in safety conditions, with power supply switched off, and after checking the non - possibility of an external switch on of the machine or of the system in which it is integrated, during these operations.

Before starting any operation, operator must wear the following safety clothes:

GLOVES



SUIT

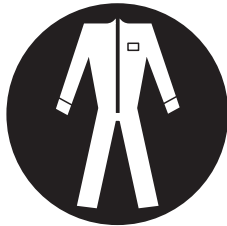

SAFETY  
SHOES



HELMET



## 6.2 ACTUATOR SERVICE OPERATIONS



**BEFORE STARTING WITH ANY SERVICE OPERATION, CHECK THAT THE TEMPERATURE OF THE PARTS IS NOT SO HOT TO CAUSE DAMAGES, INJURIES OR BURNS TO THE OPERATOR. IN THIS CASE, WAIT UNTIL THE PARTS ARE COOLER.**

Actuator needs only few service operations: cleaning and eventually greasing (if necessary, lubricant has to be added by the appropriate lubricator).

*REMARK: Lubricants that can be used are listed in chapter 2 TECHNICAL FEATURES of this handbook.*

Anyway, MecVel s.r.l. recommends a scheduled inspection on actuator or screwjacks to detect any problem, especially about movements and in case of noises.

The schedule of the checks should vary according to the application and the use: in case of continuative use or for any doubts, please contact the Technical Department of MecVel s.r.l.

It is necessary to frequently check the nut wear.

To do this, follow this procedure:

1. disconnect load from actuator;
2. put load on push rod, according to model rating (from nominal load till 0.1 times nominal load, lowering this parameter the more actuator size is high);
3. with a dial - gauge, putting both compressing and tensile load, check that axial backlash is always lower than 0,3 times the screwpitch.

In case backlash is higher, then actuator needs to be replaced.

It is necessary to periodically check:

- the isolation and preservation of the cables;
- the cable inlets;
- the preservation of the external surfaces, with particular attention to the parts in movement and their shelters.

### 6.3 ACTUATOR REPAIR



**IF SOMETHING WRONG IS DETECTED, DO NOT TRY TO REPAIR IT BY YOUR OWN, BUT CONTACT AFTER-SALES DEPT. OF MECVEL TO GET THE NECESSARY INSTRUCTIONS.**

All the repairs must be done by qualified technicians, adequately informed and trained about the dangers, arising from them. Moreover, it is important to consider the integration and usage of the actuator into more complicated systems.

Every repair must be fulfilled in safety conditions, with power supply switched off, and after checking the non - possibility of an external switch on of the machine or of the system in which it is integrated.

If the actuator is installed in dangerous environment, the operator must behave accordingly, for example, wearing protecting clothes and tools.



### 6.4 ACTUATOR REPLACEMENT

It is necessary to replace the actuator, in the following cases: if it breaks, if it is not working correctly for its use and if the whole system or application on which it is installed is dismantled. In these cases, the operator must take care to follow the safety instructions about actuator service, explained in this handbook.

If the actuator has problem of functioning or control, please get in touch with the Technical Service of MecVel s.r.l. for the instructions and the authorizations about replacement or repair.

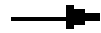
REMARK: For the Technical Service MecVel is important the O.P. number written on the label on the motor.



		<b>Via Due Portoni, 23 40132 Bologna – I – Tel. +39 051 4143711</b>
CERTIFICATA/CERTIFIED UNI EN ISO9001:2008		
DATA/DATE .....		COD.
O.P. ....		MOD./MODEL ALI1
CORSA/Stroke .....		VEL./Speed .....
RAPP./Ratio .....		Mot.
SERVIZIO/Duty cycle		S3 30%
		

ENGLISH

## 7 MANUAL DRIVE

In case of emergency, it is possible to move the actuator manually, as described in section 5, *WORKING AND USE* of this handbook.

Please take the greatest care during these operations and follow carefully the guidelines of this handbook, in particular:

- be sure that load is safely held, braked and/or supported by external tools;
- be sure that the environment is not intrinsically dangerous during the emergency operation (bad lighting, smoke or gases or toxic and burning vapours, etc.);
- use safety tools and wear safety clothes;
- do not proceed with emergency operation without some personnel that can help the operator in case of unexpected danger.

### MANUAL DRIVING

A manual driving system is available, for emergency situations.

By removing the cap support, movement can be controlled using a screwdriver.

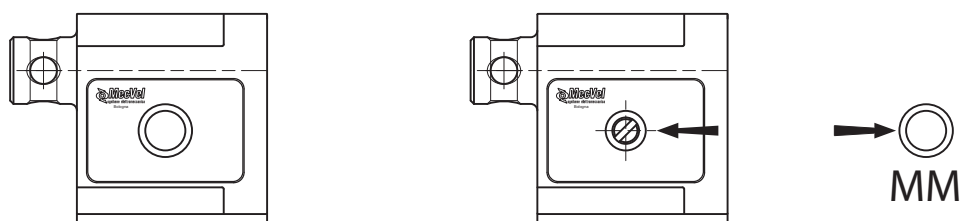

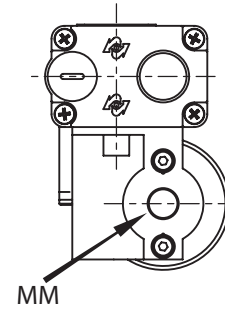
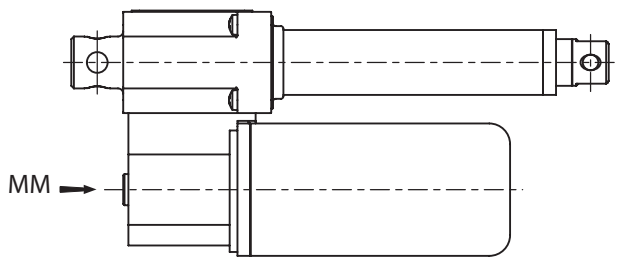

## 8 INTERACTION WITH THE OPERATOR

This section cannot be applied, because the actuator has no interaction with the operator. External drive is possible only in case of service, repair or emergency. In these cases, remember to switch off power supply of the actuator and be sure that hot surfaces are cool and parts in movement are still.

Please refer to chapter 6, *ACTUATOR MAINTENANCE* for all the necessary hints to safely fulfill these operations.

## 9 GENERAL WARRANTY CONDITIONS

For general sales conditions consult the catalog or website [www.mecvel.com](http://www.mecvel.com).

## 10 REMARKS

Particular guidelines for the use and maintenance of customized actuators are available only in case of special configurations.

---

---

---

---

---

---

---

---

---

---

---

---

---

---

---

---

---

---

---

---

---

---

---

---

ENGLISH





MecVel S.r.l. - Via Due Portoni, 23 - 40132 Bologna - ITALIA - Tel. +39 051  
4143711 - Fax +39 051 404567

[www.mecvel.com](http://www.mecvel.com)